

Amēda MyaJoyPLUS™

Double Electric Breast Pump

EN Instructions for use

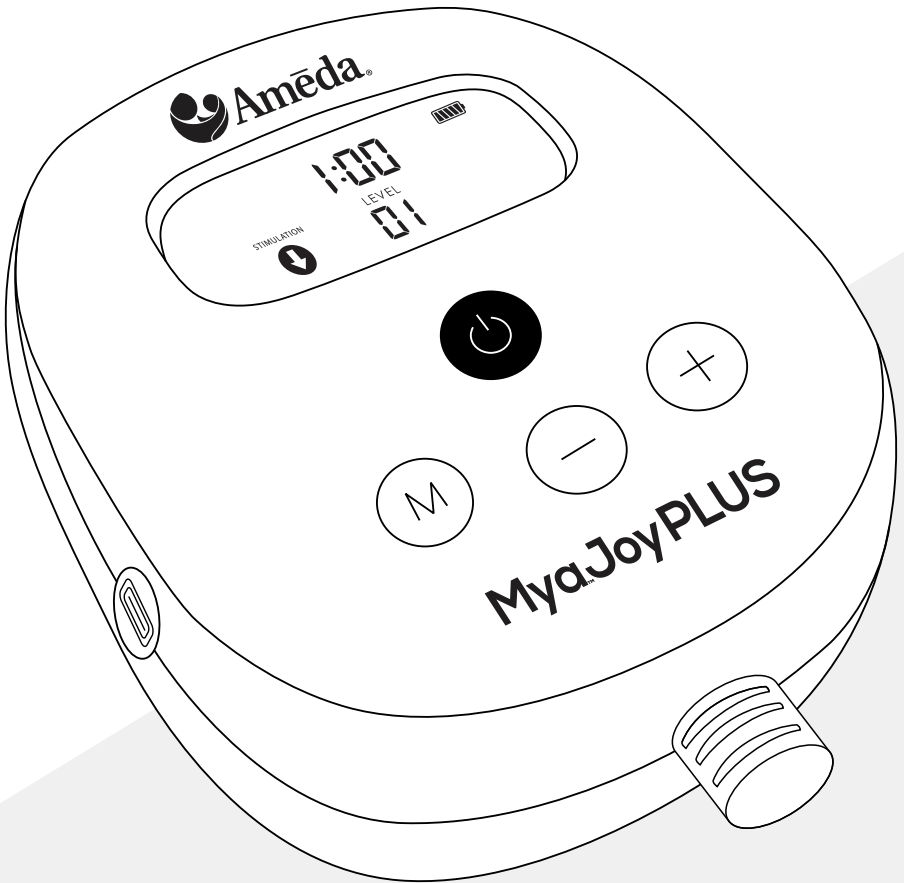

Congratulations on joining the Ameda family!

We are excited to help you meet your breastfeeding goals along your breastfeeding journey with your baby. With our Ameda breast pump and HygieniKit® Milk Collection System, you can express and collect your breast milk safely and effectively.

The Ameda HygieniKit is a closed system that contains a diaphragm that keeps the air from the pump and tubing separate from the pump parts that are exposed to your breast milk, so your tubing stays dry. This diaphragm helps prevent milk backup into tubing.



























If you have any questions regarding your Ameda breast pump or HygieniKit, we have a certified customer service ParentCare team available to help you. Have your breast pump and parts nearby when you call. ParentCare is available by phone during business hours on weekdays at **1.866.992.6332**. Please check **www.ameda.com** for up-to-date available times.

For more information about breastfeeding, breast pumping or Ameda products visit **www.ameda.com**. For more product information or feedback in other countries, visit **www.ameda.com** for a list of distributors outside of the United States.

EN TABLE OF CONTENTS

| | |
|---|----|
| 1. WARNINGS & CAUTIONS | 5 |
| 2. INTENDED USE | 7 |
| 3. CONTRAINDICATIONS | 7 |
| 4. PRODUCT DESCRIPTION | 8 |
| 5. SET-UP INSTRUCTIONS | 9 |
| 5.1 Before First Use: Cleaning The HygieniKit® | 9 |
| 5.2 Assembling the HygieniKit® Milk Collection System | 10 |
| 6. INSPECTING BEFORE PUMPING | 12 |
| 7. OPERATING INSTRUCTIONS | 12 |
| 7.1 Plug into Power Source | 12 |
| 7.2 Button Control | 12 |
| 7.3 LCD Icons & Modes | 13 |
| 7.4 To Begin Pumping | 14 |
| 7.5 How to Fit Your Flange | 16 |
| 7.6 Breast Milk Storage Guidelines | 16 |
| 8. CLEANING THE HYGIENIKIT | 17 |
| 9. MAINTENANCE | 18 |
| 9.1 Breast Pump Valve Check | 18 |
| 9.2 Storing & Transporting | 18 |
| 10. TROUBLESHOOTING | 18 |
| 11. WARRANTY | 20 |
| 12. TECHNICAL DATA | 21 |
| 12.1 Specifications | 21 |
| 12.2 Electromagnetic Compatibility | 22 |
| 12.3 Product Disposal | 26 |
| 13. OPERATIONAL & STORAGE CONDITIONS | 26 |
| 14. TRAVEL | 26 |
| 15. AMEDA ACCESSORIES AND SPARE PARTS | 27 |
| 16. SYMBOLS REFERENCE | 28 |

Icon Glossary See reference detail in Section 16

| | | | |
|--|---|--|--|
|  Warning |  Temperature Range ⁴ |  Unit of Measure |  UL Safety Certification Mark |
|  Caution |  Humidity Range ⁵ |  Class II electrical appliance (double insulated) ¹¹ |  For Indoor Use Only ¹⁷ |
|  Important |  Defines the atmospheric pressure range ⁶ |  Type BF Applied Part ¹² |  Non-ionizing Electromagnetic Radiation ¹⁸ |
|  Refer to instruction manual |  Expiration |  Waste Electrical and Electronic Equipment ¹³ | |
|  Fragile, handle with care ¹ |  Manufacturer ⁷ |  IP22 Solid Particle/Liquid Ingress Classification | |
|  Protect from sunlight ² |  LOT Batch Code ⁸ |  This symbol indicates alternating current ¹⁴ | |
|  Keep Dry ³ |  SN Serial Number ⁹ |  This symbol indicates direct current ¹⁵ | |
|  Wash hands |  REF Catalogue Number ¹⁰ |  On/Off Button ¹⁶ | |

1. WARNINGS & CAUTIONS

IMPORTANT SAFEGUARDS



When using electrical products, especially if children are present, the following basic safety precautions should always be followed.

READ ALL INSTRUCTIONS BEFORE USING THIS PRODUCT

WARNING:

- Always unplug electrical product immediately after use.
- **DO NOT** use while bathing, showering or swimming.
- **DO NOT** place or store where product can fall or be pulled into a bathtub, shower, sink, or pool.
- **DO NOT** place or drop product into water or other liquid.
- **DO NOT** use an electrical outlet that has been exposed to water or other liquids.
- **DO NOT** reach for electrical product that has fallen into water. Immediately unplug from electrical outlet.
- **DO NOT** run water over breast pump.

The following symbols identify all instructions that are important to safety. Failure to observe these instructions can lead to injury or damage to the breast pump or yourself.

| | |
|---|---|
|  | WARNING Can lead to serious injury or death. |
|  | CAUTION Can lead to minor injury. |
|  | IMPORTANT Can lead to material damage. |



WARNING: To avoid fire, electrocution, serious burns or injury:

- **NEVER** leave product unattended when plugged into an electrical outlet.
- Close supervision is necessary when product is used near children or persons with disabilities.
- Use product for its intended use **ONLY**, as described in this manual.
- **DO NOT** use parts that are not recommended by the manufacturer.
- Prior to use, always inspect power adapter for damage or exposed wires. If damage and/or exposed wires are found, do not use power adapter and call Ameda Customer Service ParentCare at **1.866.992.6332**.
- **NEVER** operate electrical product: if it has a damaged cord or plug; if it is not working properly; if it has been dropped, damaged, or becomes wet.
- Keep cord away from heated surface.
- **NEVER** use while sleeping or when drowsy.
- **NEVER** insert or drop any object into any opening or into tubing.
- **KEEP AWAY** from heated surfaces or open flames, the breast pump and detachable components are not heat-resistant.
- **DO NOT** use near flammable materials.

Environmental Conditions That Affect Use

- **DO NOT** use outdoors with electrical cord.
- **DO NOT** operate where oxygen or aerosol spray products are being used.



WARNING: To avoid health risk and reduce the risk of injury:

This product is a personal care item and intended for use by only one user. This product should not be shared between users or resold or given from one user to another. Pumping does not prevent transmission of substances or infections carried via breast milk to baby.

Note: Do not use product if damaged. Use product only for intended use as described in this manual.

- **DO NOT** use pump while driving.
- Pumping can induce labor, **DO NOT** use while pregnant unless approved by your breastfeeding specialist or healthcare professional.
- **DO NOT** pump while sleeping, it could result in tissue damage.
- Prior to first use and after every use, clean all parts (flange, diaphragm, valve and bottle) that come in contact with your breast and breastmilk.
- **DO NOT** use attachments other than those recommended by manufacturer.
- **DO NOT** make mechanical or electrical modifications to breast pump base.
- Inspect all appropriate pump components before each use. Check the parts for cracks, chips, tears or wear. If damaged, **DO NOT** use, contact Ameda Customer Service ParentCare at **1.866.992.6332** immediately.
- **DO NOT** repair yourself. Do not modify the device or parts, please contact manufacturer for any help.
- **DO NOT** continue pumping for more than 2 consecutive pumping sessions if no results are achieved.
- **DO NOT** heat or thaw frozen breastmilk in a microwave or boiling water. Microwaving can heat liquids unevenly. Both microwaving and boiling water can result in burns.
- Clean and sanitize all parts that come into contact with your breast and breast milk prior to first use.
- If you are a mother who is infected with Hepatitis B, Hepatitis C or Human Immunodeficiency Virus (HIV), pumping breast milk will not reduce or remove the risk of transmitting the virus to your baby through your breast milk.
- If irritation or discomfort occurs, discontinue use and see a doctor.
- Accessible materials may cause allergic reactions.

STRANGULATION HAZARD: Keep tubing and power adapter cords out of reach of children or persons with disabilities.

CHOKING HAZARD: Small parts, **NOT** for children under 3 years.



CAUTION: Can lead to minor injury:

- **BATTERY CANNOT BE REMOVED.**
- **DO NOT** wrap cord around the body of the adapter.
- Use **ONLY** the AC power adapter that is recommended for the Ameda Mya Joy PLUS Breast Pump.
- **DO NOT** turn on the breast pump in an aircraft.
- **DO NOT** shorten tubing or modify the breast pump kit.
- Make sure the voltage of the power adapter is compatible with the power source.
- Plug the AC power adapter into the pump base prior to plugging into the wall socket.
- Keep away from dust, lint and direct sunlight, as damage may occur to breast pump where speed and suction may be reduced.
- **DO NOT** attempt to remove the breast flange from your breast while pumping. If you are not feeling comfortable or feeling pain with pumping, turn off the pump, break the seal between the breast and breast flange with your finger, and remove breast flange from your breast gently.
- **ALWAYS** place pump on a horizontal flat surface when using product.
- This product contains a Lithium-ion battery. The battery or internal components cannot be replaced. **DO NOT** attempt to open pump base.
- Wash all parts that are exposed to breast milk immediately after use. This will help remove breast milk residue and prevent growth of bacteria.



IMPORTANT: Can lead to material damage.

- **NEVER** put electrical product in water or a sterilizer, as you can cause permanent damage to the breast pump.
- **DO NOT** use antibacterial or abrasive cleaners/detergents when cleaning breast pump or breast pump parts.
- When plastic bottles and plastic breast pump kit parts are frozen, they can become brittle and may break when dropped.
- **DO NOT** over-fill bottles. Replace bottles before they overflow.
- Bottles and breast pump kit parts may become damaged if mishandled, e.g. dropped, overtightened, or knocked over.
- Always check bottles or breast pump kit parts prior to pumping. Discard breastmilk if bottles or breast pump kit parts are damaged.



SAVE THESE INSTRUCTIONS

2. INTENDED USE

The Ameda Mya Joy PLUS Breast Pump is a single-user, powered breast pump intended to express and collect milk from the breasts of lactating women.

3. CONTRAINDICATIONS FOR USE

There are no known contraindications for use with this product.

4. PRODUCT DESCRIPTION

Ameda Mya Joy PLUS & HygieniKit® Milk Collection System

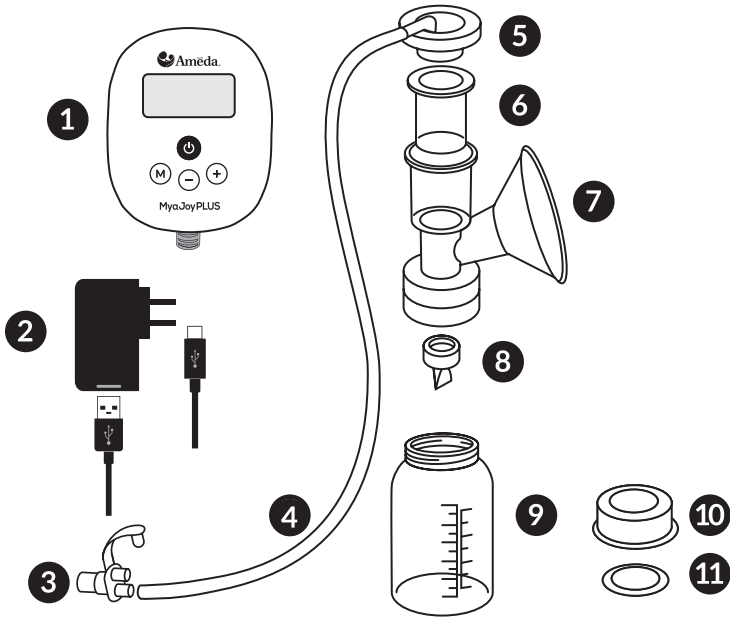

Pump Assembly

1. Ameda Mya Joy PLUS Pump Unit

2. AC Power Adapter (with USB-C connection)

Ameda HygieniKit
Milk Collection System

3. Tubing Adapter

4. Tubing

5. Adapter Cap

6. Diaphragm

7. Breast Flange (25.0mm)

8. Silicone Valve

9. Bottle

10. Bottle Locking Ring Cap

11. Bottle Locking Disc

Pump parts may vary

NOTE: Only use the kit and replacement parts that came with this pump.

5. SET-UP INSTRUCTIONS

5.1 Before First Use: Cleaning The HygieniKit

Sanitizing is important for hygiene and serves to kill living organisms, such as bacteria or viruses.

Refer to the cleaning and disinfection section for the continued cleaning of your device. Before first use, unless otherwise directed by your healthcare provider, prepare the product for use as follows:

1. Disassemble all parts & clean using breast pump cleaning instructions. See the Center for Disease Control website –<https://www.cdc.gov/healthywater/hygiene/healthychildcare/infantfeeding/breastpump.html> for additional cleaning guidelines.
2. **POP OFF** the adapter cap from the flange and refer to the page 8 product description for the illustration.
3. **SET ASIDE** adapter cap, tubing and tubing adapter— you do not need to take these apart from each other. These 3 parts **DO NOT** need to be washed before first use or after each use — milk does not come into direct contact with these parts.

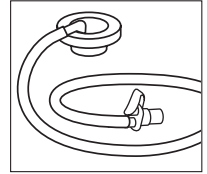

DO NOT wash adapter cap, tubing and tubing adapter.

NOTE: Inspect the tubing. If you find condensation in the air tube, wash and dry it immediately or replace the tubing. If you see breast milk inside the tubing or tubing connector do not attempt to wash, clean or sterilize the tubing or tubing connector. Instead contact Ameda, Inc.

Take apart the remaining parts, the diaphragm, flange, valve and milk storage bottles, including locking ring and locking disc, since these are the parts that can touch the breast milk once you begin pumping.



WASH HANDS THOROUGHLY with soap and water before touching breast pump, kit and breasts.



SANITIZE by Boiling

DO NOT allow boiling parts to contact bottom of pot. It may cause damage to parts.



WARNING: DO NOT leave boiling parts unattended. Remove parts carefully from boiling water to avoid burning. Boiled water and steam from boiled water can cause severe skin burns, so use caution when boiling parts in water and removing parts from boiling water.

ALTERNATIVE TO BOILING:



SANITIZE in Microwave: Follow steam bag manufacturers' instructions.

IMPORTANT: Set aside tubing, adapter cap and tubing adapter. These parts **DO NOT** need to be washed.

- Please check pump kit parts for cracks, chips, tears or deformation before and after sanitization process.

Use only microwave bags specifically labeled for disinfecting breast pump components and refer to the microwave bag labeling for further instructions.



WARNING: Please use precaution. The major risk with steam bags is scalding so moms and caregivers should be very careful when they take the bag out of the microwave.

CLEAN TUBING: It is necessary to wash the tubing only if condensation is present. If condensation is present in the tube, wash and dry it immediately or replace the tubing. If milk is present in the tubing, do not attempt to wash or clean the tubing. Instead contact Ameda Customer Service at 1.866.992.6332.

HOW TO WASH TUBING:

1. Rinse the tubing by pouring cool water and make sure the water flows through the entire tubing from one end to the other end.
2. Wash the tubing in warm, soapy water and rinse thoroughly.

HOW TO DRY TUBING:

Hang the tubing to air dry and make sure that the tubing is completely dry before using.

5.2 Assembling the HygieniKit® Milk Collection System

Once your pump parts are completely dry before use, wash your hands thoroughly and assemble the HygieniKit® Milk Collection System (Pump Kit).

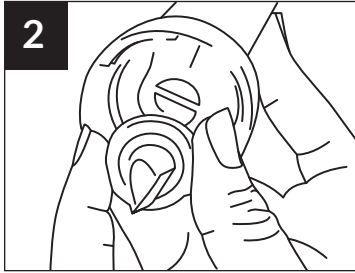
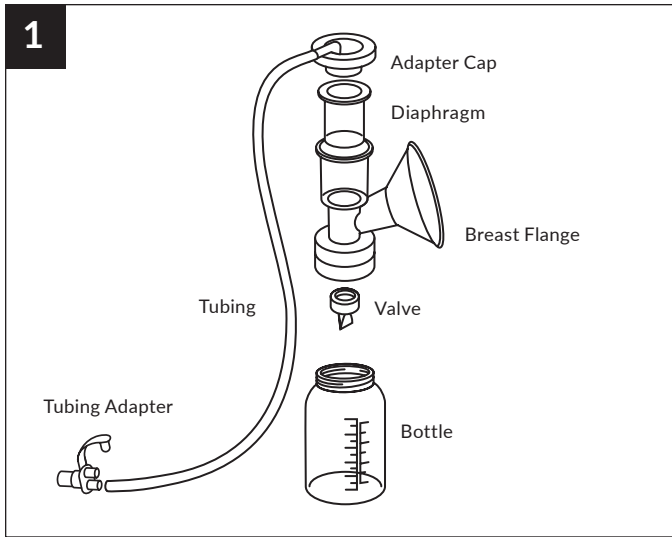

HOLD by the rim or thicker sides of the valve.

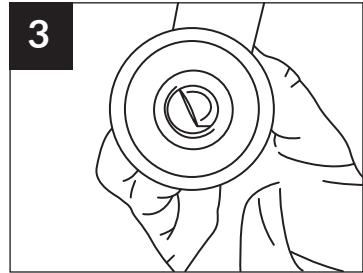

PUSH the valve onto the bottom of the flange.

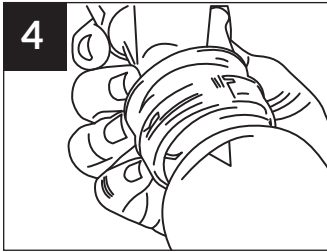

ATTACH and **TIGHTEN** the bottle or attach milk storage bag.

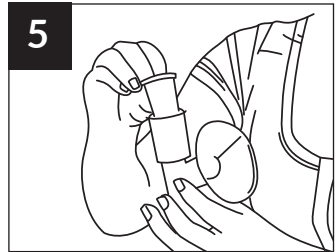

INSERT the diaphragm into the top of the flange.

It is important that the inside of the diaphragm is completely DRY to avoid moisture from forming in the tubing.

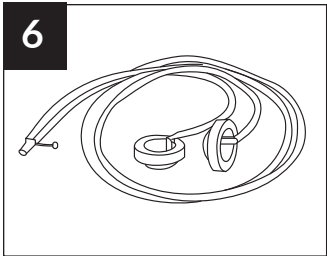

ATTACH the adapter cap(s) by pressing it onto the top of the flange(s) until you hear a pop.



The tubing should still be **CONNECTED** to the adapter cap(s) and tubing adapter.

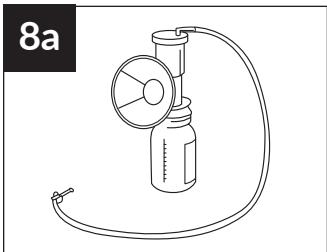

ASSEMBLED HYGIENIKIT for single pumping.

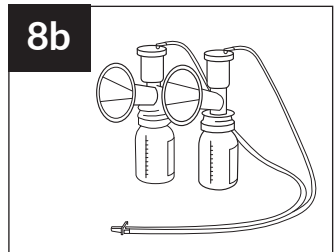

ASSEMBLED HYGIENIKIT for double pumping.

Pump parts may vary.

6. INSPECTING BEFORE PUMPING



IMPORTANT: Before using the Ameda Mya Joy PLUS and HygieniKit® system, check the parts for cracks, chips, tears, or wear. They can affect the function of the kit. If parts need replacing due to defects, please call your local distributor or the location where you purchased the pump. Do not use damaged parts. For a listing of distributors in your country, please visit www.ameda.com.

7. OPERATING INSTRUCTIONS

7.1 Plug into Power Source

Choosing and checking your electrical source

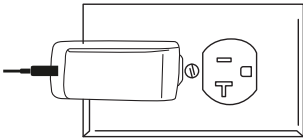

AC POWER ADAPTER



WARNING: Use **ONLY** the AC power adapter recommended for the Ameda Mya Joy PLUS Pump.



WARNING: Always inspect the AC power adapter for damage such as kinking or twisting of cords or frayed or exposed wires. If damaged, discontinue use immediately and call customer service at **1.866.992.6332**.

1. **PUSH** small end of AC power adapter into left side of the pump base (USB-C Connection) as shown in section 7.4 to Begin Pumping.
2. **PLUG** other end into AC outlet.

7.2 Button Control

A. POWER ON/OFF BUTTON

B. MODE SELECTION BUTTON

Switches between Stimulation Mode and Expression Mode

C. - / + VACUUM LEVEL

Decreases or increases suction strength during pumping

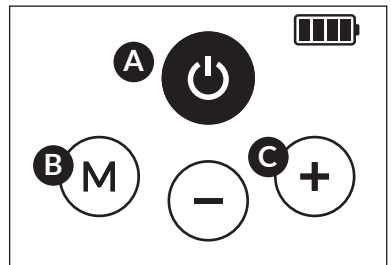

7.3 LCD Icons & Modes

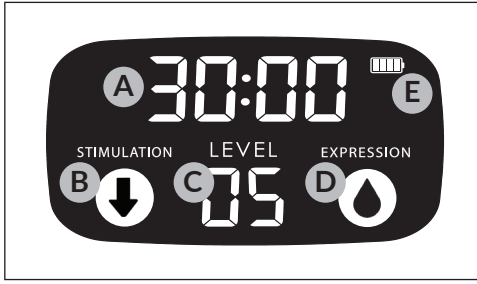

A. TIMER DISPLAY

Tracks pumping time. Pump automatically shuts-off after 45 minutes.

B. STIMULATION MODE



Mimics baby's fast suction pattern with fast speed and low suction to start milk flowing. This icon will disappear when in Expression Mode.

NOTE: After two minutes, the pump will automatically switch to Expression Mode unless you manually adjust beforehand.

C. SUCTION STRENGTH LEVEL

Level of suction strength during pumping. The Ameda Mya Joy PLUS has two suction modes (Dual-Phase), each with adjustable suction levels:

- Stimulation Mode: 1 - 6 levels
- Expression Mode: 1 - 12 levels

Adjust the suction level by pressing the  or  button to decrease and increase levels, respectively.

D. EXPRESSION MODE

Mimics baby's slow, steady suction pattern with slower speed and higher suction to express more milk gently and efficiently. This icon will disappear when in Stimulation Mode.

E. BATTERY LEVEL

Standard charge time, 0 to 100% capacity: At least 2.5 hours. Blinking battery percentage bars = battery charging. Battery life fully charged 150 minutes. (typical)

Battery Icon Status and approximate remaining run time:



157 Minutes



80 Minutes



134 Minutes



39 Minutes

7.4 To Begin Pumping

STEP 1: INSERT TUBING

Insert Tubing adapter into the right side of the pump base, then turn the pump slightly to the right, and gently push it to make sure it connects firmly.

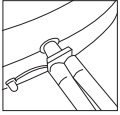

A. For **DOUBLE PUMPING**: Both tubes should be attached to the tubing adapter.

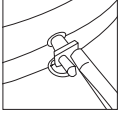

B. For **SINGLE PUMPING**: Remove one tube from the tubing adapter and close one side using the attached plug.

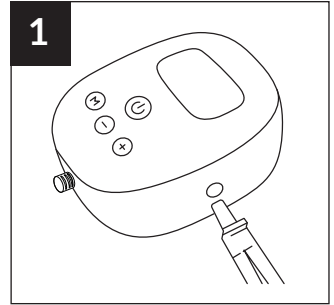

STEP 2: PLACE THE FLANGE ON BREAST

Center flange on breast to create seal.

Check breast flange fit, if pumping causes discomfort a larger or smaller breast flange size may be needed. See section on how to properly fit your flange.

See section 7.5 below on how to properly fit your flange.

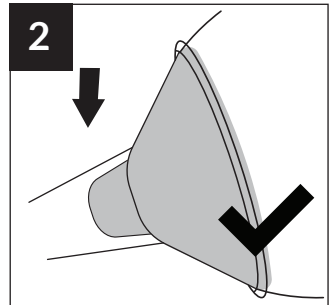

STEP 3: POWER ON THE PUMP

Press the Power button to turn on the device. It will begin in Stimulation Mode.

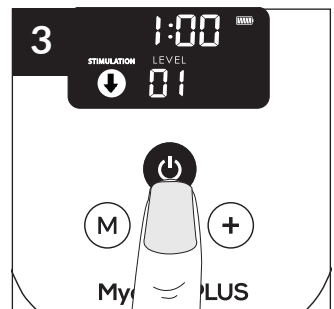

STEP 4: ADJUST VACUUM LEVEL

Adjust the Stimulation Vacuum Level between 1 and 6 to your preferred comfort level. Never set to uncomfortable level.

TIP: Start off with the suction low, and then gradually increase the suction setting to your most comfortable level. You may find that the level of suction that you are comfortable with varies from day to day, during the day and even during the same expression session.

NOTE: After two minutes, the pump will automatically switch to Expression Mode unless you manually adjust prior.

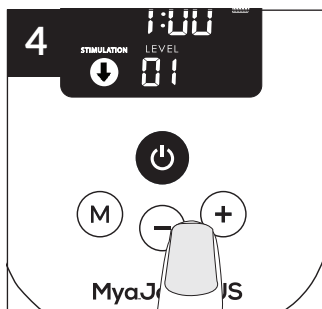

STEP 5: CHANGE MODE

Once your milk starts to flow, press the Mode button to switch into Expression Mode.

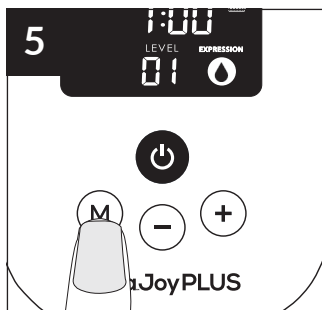

STEP 6: ADJUST VACUUM LEVEL

Adjust the Expression Vacuum Level between 1 and 12 to your preferred comfort level. Never set to uncomfortable level.

TIP: Start off with the suction low, and then gradually increase the suction setting to your comfort level. You may find that the level of suction that you are comfortable with varies from day to day, during the day and even during the same expression session.

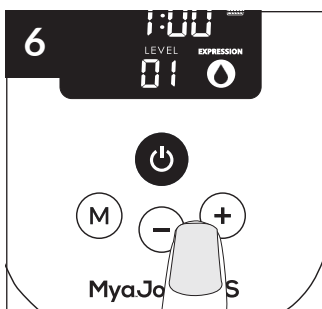

STEP 7: END PUMPING SESSION

When you wish to stop expressing milk, first press the Power button, then remove milkcollection kit from your breast.

TIP: After pump is off, if necessary, INSERT a finger between breast and breast flange to break suction.

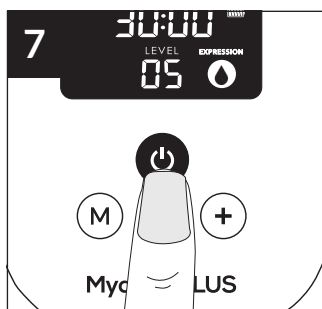

7.5 How to Fit Your Flange

Check breast flange fit, if pumping causes discomfort a larger or smaller breast flange size may be needed.

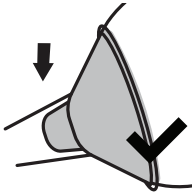

GOOD FIT

During pumping, your nipple moves freely in the breast flange tunnel. You see space around the nipple. Not much areola is drawn into the tunnel with the nipple.

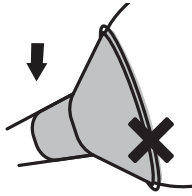

FLANGE TOO SMALL

During pumping, some or all of your nipple rubs against the sides of the breast flange tunnel.

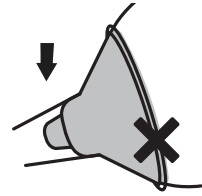

FLANGE TOO LARGE

During pumping, more areola is drawn into the breast flange with your nipple. Your areola may rub against the side of the breast flange tunnel.

7.6 Breast Milk Storage Guidelines

- 1: Write the date on the storage container. Include your child's name if you are giving the milk to a child care provider.
- 2: Gently swirl the container to mix the cream part of the breastmilk that may rise to the top back into the rest of the milk. Do not shake the milk. This can make some of the milk's valuable parts break down.
- 3: Refrigerate or chill milk right after it is pumped, if possible. You can put it in the refrigerator, place it in a cooler or insulated cooler pack, or freeze it in small (2- to 4-ounce) batches for later feedings. Pumped milk is OK without being refrigerated for up to 4 hours after pumping.

| | Room Temperature 77°F (25°C) | Time in Refrigerator 39°F (4°C) | Time in Freezer 0°F (-18°C) |
|---|--|------------------------------------|---|
| Fresh Expressed or Pumped | Up to 4 hours | Up to 4 days | 6 Months - Best 12 Months - Acceptable |
| *Thawed, Previously Frozen | 1-2 Hours | Up to 1 day (24 hours) | Do Not Refreeze |
| Leftover from Feeding (baby did not finish bottle) | Use within 2 hours after the baby is finished feeding | | |

***NOTE:** When thawing frozen milk, label as thawed when completely thawed (i.e. no ice crystals present). Use the time when completely thawed to base acceptable time limits for use rather than when it is taken from the freezer. These guidelines for storage and thawing of breast milk are a recommendation. Contact your lactation consultant or breastfeeding specialist for further information.

These guidelines are for healthy full-term babies and may vary for premature or sick babies. Check with your health care provider. Find more breastfeeding resources at: WICBreastfeeding.fns.usda.gov and www.cdc.gov/breastfeeding/

8. CLEANING THE HYGIENIKIT®

BEFORE EVERY USE



Wash hands with soap and water. **Inspect and assemble** clean pump kit. If your tubing is moldy, discard and replace immediately.

Clean pump dials, power switch, and countertop with disinfectant wipes, especially if using a shared pump.

AFTER EVERY USE

Store milk safely. Cap milk collection bottle or seal milk collection bag, label with date and time, and immediately place in a refrigerator, freezer, or cooler bag with ice packs.

Clean pumping area, especially if using a shared pump. Clean the dials, power switch, and countertop with disinfectant wipes.

Take apart breast pump tubing and separate all parts that come in contact with breast/breast milk.

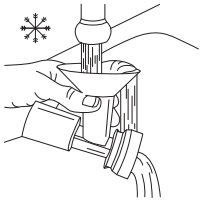

Rinse breast pump parts that come into contact with breast/breast milk by holding under running water to remove remaining milk.

Do not place parts in sink to rinse.

Clean pump parts that come into contact with breast/breast milk as soon as possible after pumping.

You can clean your pump parts in a dishwasher or **by hand** in a wash basin used only for cleaning the pump kit and infant feeding items.

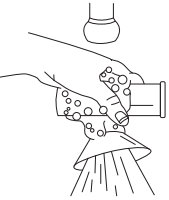

Place pump parts in a clean wash basin used only for infant feeding items. **Do not place pump parts directly in the sink!**

Add soap and hot water to basin.

Scrub items using a clean brush used only for infant feeding items.

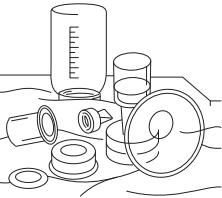

Rinse by holding items under running water, or by submerging in fresh water in a separate basin.

Air-dry thoroughly. Place pump parts, wash basin, and bottle brush on a clean, unused dish towel or paper towel in an area protected from dirt and dust. Do not use a dish towel to rub or pat items dry!

Clean wash basin and bottle brush. Rinse them well and allow them to air-dry after each use. Wash them by hand or in a dishwasher at least every few days.

For detailed instructions on sanitizing your pump parts, visit <https://www.cdc.gov/healthywater/hygiene/healthychildcare/infantfeeding.html>



IMPORTANT: The flanges and milk storage containers can also be washed on upper rack of a standard, household dishwasher. **DO NOT** use solvents or abrasives. Allow to air dry on a clean surface.

Cleaning the pump: Turn the breast pump off. Unplug the pump from the power source; wipe the pump with a clean, damp cloth and dry with a clean towel.

9. MAINTENANCE

The breast pump base does not require service or maintenance.

9.1 Breast Pump Valve and Diaphragm Check



Inspect the valves and diaphragms for tears or holes. Replace any damaged valves and diaphragms prior to pumping. Wash valves and diaphragms per cleaning section. Do not insert bottle brush or something similar into valves. We recommend replacing valves and diaphragms approximately every 8-12 weeks but this can vary depending on cleaning and use.

9.2 Storing & Transporting

Disconnect HygieniKit and power adapter from pump before transporting or storing the product. When storing product, store in conditions as described in these instructions. Handle with care when transporting product.

10. TROUBLESHOOTING

SLOW MILK FLOW, UNEVEN OR NO SUCTION

VALVE AND DIAPHRAGM CHECK

Inspect the valves and diaphragms for tears or holes.

Replace any damaged valves and diaphragms prior to pumping. Wash valves and diaphragms per cleaning section. Do not insert bottle brush or similar into valves. We recommend replacing valves and diaphragms approximately every 8-12 weeks but this can vary depending on cleaning and use.

CONNECTION CHECK

Check assembly is correct and connection points are securely attached.

- Tubing adapter to tubing port
- Tubing adapter to tubing

Check adapter cap is attached to breast flange. It may be useful to remove adapter cap and reattach to breast flange.

FLANGE/BOTTLE CHECK

Check flanges, adapter cap or bottles for chips, cracks, breaks, or other damage. Replace any damaged flanges/adapter caps/bottles prior to pumping.

BREAST FLANGE FIT CHECK

- Good Fit: Nipple is moving freely in tunnel of flange
- Too Small: Nipple is rubbing against tunnel of flange
- Too Large: Areola is being pulled into tunnel of flange
- Check to make sure the breast shields form a complete seal around the breast while pumping

| | |
|---|---|
| <p>AUDIBLE, HISSING NOISE OR AIR LEAKAGE</p> | <p>VALVE AND DIAPHRAGM CHECK</p> <p>Inspect the valves and diaphragms for tears or holes. Replace any damaged valves and diaphragms prior to pumping. Wash valves and diaphragms per cleaning section. Do not insert bottle brush or similar into valves. We recommend replacing valves and diaphragms approximately every 8-12 weeks but this can vary depending on cleaning and use.</p> <p>CONNECTION CHECK</p> <p>Check assembly is correct and connection points are securely attached.</p> <ul style="list-style-type: none"> • Tubing adapter to tubing port • Tubing adapter to tubing <p>Check adapter cap is attached to breast flange. It may be useful to remove adapter cap and reattach to breast flange.</p> |
| <p>POWER SOURCE</p> | <p>AC POWER ADAPTER</p> <p>Ameda Mya Joy PLUS is optimized for use with the AC Power Adapter provided by Ameda. The AC Power Adapter consists of an Adapter Base and USB Cable. Make sure the USB Cable is plugged all the way into the Adapter Base and the side of the pump base. Make sure the power button on the left side of the pump base is fully pressed. Make sure the outlet is working.</p> <p>BATTERIES</p> <p>The breast pump base comes equipped with a Lithium-ion rechargeable battery. Make sure the battery is charged before using it without the AC Power Adapter. The battery is not removeable or serviceable.</p> <p>NOTE: Recommend recharging lithium ion battery every 3 months if not used.</p> |
| <p>"Lo" Notification on LCD Screen</p> | <p>When the battery is too low to operate the pump, the LCD screen will display a "Lo" notification. Use the AC Power Adapter.</p> |
| <p>"ERR" Notification on LCD Screen</p> | <ul style="list-style-type: none"> • Make sure the AC Power Adapter is the correct electrical rating (Approved Ameda AC Power Adapter). • Replace the AC Power Adapter. • Contact Ameda at 1.866.992.6332 |

If there are still questions or issues please call Ameda's certified customer service ParentCare team at **1.866.992.6332**.

FCC STATEMENT

This device complies with part 15 of the FCC Rules. Operation is subject to the following two conditions: (1) This device may not cause harmful interference, and (2) this device must accept any interference received, including interference that may cause undesired operation.

Caution: Changes or modifications to this device not expressly approved by Ameda may void the user's authority to use the device.

Note:

This equipment has been tested and found to comply with the limits for a Class B digital device, pursuant to part 15 of the FCC Rules. These limits are designed to provide reasonable protection against harmful interference in a residential installation. This equipment generates, uses and can radiate radio frequency energy and, if not installed and used in accordance with the instructions, may cause harmful interference to radio communications. However, there is no guarantee that interference will not occur in a particular installation. If this equipment does cause harmful interference to radio or television reception, which can be determined by turning the equipment off and on, the user is encouraged to try to correct the interference by one or more of the following measures:

- Reorient or relocate the receiving antenna.
- Increase the separation between the equipment and receiver.
- Connect the equipment into an outlet on a circuit different from that to which the receiver is connected.
- Consult the dealer or an experienced radio/TV technician for help.

11. WARRANTY

THE AMEDA WARRANTY IS NONTRANSFERABLE BETWEEN INDIVIDUALS. THE AMEDA MYA JOY PLUS ELECTRIC BREAST PUMP ("PRODUCT") IS WARRANTED TO THE ORIGINAL USER – WHETHER INSTITUTIONAL OR INDIVIDUAL ("FIRST USER") – ONLY.

From the date of the Individual User's purchase of this product, Ameda Company, Inc. ("Ameda") warrants the Product to the Individual User against defects in material or workmanship for a period of two years for the pump mechanism and 90 days on other pump components except for breast pump valves. Ameda's sole obligation under this limited warranty shall be to repair or replace, at Ameda's option, any Product that is determined to be defective by Ameda and determined to be covered by this express limited warranty. Repair or replacement under this limited warranty is the sole and exclusive remedy of the First User.

PROOF OF PURCHASE IN THE FORM OF A RECEIPTED INVOICE OR BILL OF SALE EVIDENCING THAT THE PRODUCT IS WITHIN THE WARRANTY PERIOD MUST BE PRESENTED TO OBTAIN WARRANTY SERVICE.

This limited warranty is extended by Ameda ONLY to the First User and is not assignable or transferable. For warranty service contact Ameda at **1.866.992.6332**.

EXCEPT TO THE EXTENT PROHIBITED BY APPLICABLE LAW, ANY IMPLIED WARRANTY OF MERCHANTABILITY OR FITNESS FOR A PARTICULAR PURPOSE ON THE PRODUCT IS HEREBY DISCLAIMED. AMEDA SHALL NOT BE LIABLE FOR ANY INCIDENTAL, CONSEQUENTIAL, SPECIAL OR PUNITIVE DAMAGES OF ANY KIND FOR BREACH OF THE EXPRESS LIMITED WARRANTY ON THE PRODUCT OR ANY WARRANTY IMPLIED BY OPERATION OF LAW. OTHER THAN THE EXPRESS LIMITED WARRANTY SET FORTH ABOVE, THERE ARE NO OTHER WARRANTIES THAT ACCOMPANY THIS PRODUCT AND ANY ORAL, WRITTEN OR ANY OTHER REPRESENTATION OF ANY KIND IS HEREBY DISCLAIMED.

NON-APPLICABILITY OF WARRANTY

In addition to any other limitations on the warranty discussed above, the warranty shall expire and be of no force or effect upon the occurrence of any of the following:

- (i) the cause of damage to the Product is due to improper handling or use.
- (ii) opening of the pump motor, modifications, self-repair or use outside the instructions in this manual voids warranty.
- (iii) the Product is not properly maintained by the Individual User as determined by Ameda.
- (iiii) non-Ameda approved accessories or spare parts are used with the Product as determined by Ameda.

If any of the above occurs, Ameda shall not be responsible for damage to the Product, parts thereof or injuries arising therefrom, either directly or indirectly. The warranty terms set forth above replaces all prior warranties with respect to the purchased Product, whether in writing or otherwise.

Outside the United States: Call your local distributor or location where you purchased the Product. For a listing of distributors in your country, please visit www.ameda.com.

12. TECHNICAL DATA

12.1 Specifications

| Product Description | Electric Breast Pump |
|------------------------------------|--|
| Model | Ameda Mya Joy PLUS |
| | The pump is capable of single and double pumping. |
| Suction | Stimulation mode: Dual-Kit: 40 to 100 mmHg |
| | Stimulation mode: Single-Kit: 80 to 160 mmHg |
| | Expression mode: Dual-Kit: 50 to 250 mmHg |
| | Expression mode: Single-Kit: 80 to 250 mmHg |
| Vacuum Levels | Stimulation mode: 6 Levels |
| | Expression mode: 12 Levels |
| Cycles Per Minute | Stimulation mode: 80 to 120 C.P.M. |
| | Expression mode: 20 to 65 C.P.M. |
| Breastshield Sizes | 25mm |
| Power Source | AC Adapter – Output: 5VDC, 1000mA. Input: 100-240VAC, 50/60Hz, 0.25A. Model # MPSUL0501000 |
| | 1500mAh Lithium-ion rechargeable battery |
| Battery Life | At least 2 hours after full charge cycle |
| Additional Function | Automatic Power-off after 45 min |
| Unit Weight | Approx. 328.4 g (11.6oz) |
| Unit Dimensions | 110 x 93 x 55mm (L x W x H) |
| Operating Environment | Temperature: 5°C to 40°C (41°F to 104°F) |
| | Humidity: 15 to 93%RH |
| | Pressure: 86kPa to 106kPa |
| Storage Environment Transportation | Temperature: -20°C to 55°C (-4°F to 131°F) |
| | Humidity: 15 to 93%RH |
| Expected Service Life | Your device has been designed and developed with the greatest possible care and has an expected service life of 400 hours. |
| Ingress Protection Rating | IP22 |
| Classification | Internal Powered Equipment, Type BF Applied Part |
| Protection Class | Class II/Double Insulated  |

Specifications are subject to change without notice.

This appliance conforms to the following standards:

IEC 60601-1-11 Medical electrical equipment –Part 1-11: General requirements for basic safety and essential performance –Collateral Standard: Requirements for medical electrical equipment and medical electrical systems used in the home healthcare environment and complies with the requirements of IEC 60601-1-2 (EMC), and AAMI/IEC 60601-1 (Safety) standards. The manufacturer is ISO 13485 certified.

12.2 Electromagnetic Compatibility

The essential performance of the Mya Joy PLUS breast pump is to not exceed 270 mmHg. The pump was tested for immunity to electromagnetic disturbances and passed according to these criteria.

TABLE 1

| Guidance and declaration of manufacturer-electromagnetic emissions. | | |
|--|------------------|---|
| The device is intended for use in the electromagnetic environment specified below. The customer or the user of the device should assure that it is used in such an environment. | | |
| Emissions test | Compliance | Electromagnetic environment - guidance |
| RF emissions CISPR 11 | Group 1, class B | The device uses RF energy only for its internal function. Therefore, its emissions are very low and are not likely to cause any interference in nearby electronic equipment. |
| RF emissions CISPR 11 | Group 1, class B | The device is suitable for use in all establishments, including domestic establishments and those directly connected to the public low-voltage power supply network that supplies buildings used for domestic purposes. |
| Harmonic emissions IEC 61000-3-2 | Class A | |
| Voltage fluctuations/ flicker emissions IEC 61000-3-3 | Complies | |

WARNING: Do not use this device in adjacent to or stack this device with other equipment. If adjacent or stacked use is necessary, the device should be observed to verify normal operation condition.

TABLE 2

| Guidance and declaration of manufacturer-electromagnetic immunity. (For home healthcare environment) | | | |
|---|--|--|---|
| The device is intended for use in the electromagnetic environment specified below. The customer or the user of the device should assure that it is used in such an environment | | | |
| IMMUNITY test | IEC 60601 test level | Compliance level | Electromagnetic environment - guidance |
| Electrostatic discharge (ESD) IEC 61000-4-2 | ± 8 kV contact discharge ±2 kV, ±4 kV, ±8 kV, ±15 kV air discharge | ± 8 kV contact discharge ±2 kV, ±4 kV, ±8 kV, ±15 kV air discharge | Floors should be wood, concrete or ceramic tile. If floors are covered with synthetic material, the relative humidity should be at least 30 %. |
| Electrical fast transients/bursts IEC 61000-4-4 | ± 2 kV for AC power port, 100kHz repetition frequency | ± 2 kV for AC power port, 100kHz repetition frequency | Mains power quality should be that of a typical commercial or hospital environment. |
| Surge IEC 61000-4-5 | ±0.5kV, ±1kV (line-to-line) | ±0.5kV, ±1kV (line-to-line) | Mains power quality should be that of a typical commercial or hospital environment. |
| Voltage dips, short interruptions and voltage variations on power supply input lines IEC 61000-4-11 | 0 % UT; 0,5 cycle At 0°, 45°, 90°, 135°, 180°, 225°, 270° and 315° 0 % UT; 1 cycle and 70 % UT; 25/30 cycles Single phase: at 0° 0 % UT; 250/300 cycle | 0 % UT; 0,5 cycle At 0°, 45°, 90°, 135°, 180°, 225°, 270° and 315° 0 % UT; 1 cycle and 70 % UT; 25/30 cycles Single phase: at 0° 0 % UT; 250/300 cycle | Mains power quality should be that of a typical commercial or hospital environment. |
| Power frequency (50/60 Hz) magnetic field IEC 61000-4-8 | 30 A/m; 50Hz or 60Hz | 30 A/m; 50Hz or 60Hz | Power frequency magnetic fields should be at levels characteristic of a typical location in a typical commercial or hospital environment. It maybe necessary to position the pump further from the sources of power frequency magnetic fields. The power frequency magnetic field should be measured in the location to assure that it is sufficiently low. |

TABLE 3

| Guidance and declaration of manufacturer-electromagnetic immunity. (For home healthcare environment) | | | |
|--|--|--|---|
| The device is intended for use in the electromagnetic environment specified below. The customer or the user of the device should assure that it is used in such an environment. | | | |
| IMMUNITY test | IEC 60601 test level | Compliance level | Electromagnetic environment guidance |
| Conducted RF IEC 61000-4-6 | 3V for 0.15- 80MHz; 6V in ISM and amateur radio bands between 0.15- 80MHz 80% AM at 1kHz | 3V for 0.15- 80MHz; 6V in ISM and amateur radio bands between 0.15- 80MHz 80% AM at 1kHz | Portable RF communications equipment (including peripherals such as antenna cables and external antennas) should be used no closer than 30 cm (12 inches) to any part of the Mya Joy PLUS, including cables specified by the manufacturer. Otherwise, degradation of the performance of this equipment could result. |
| Radiated RF IEC 61000-4-3 | 10V/m, 80MHz - 2.7GHz, 80% AM at 1kHz | 10V/m, 80MHz - 2.7GHz, 80% AM at 1kHz | |
| Proximity fields from RF wireless communications equipment IEC 61000-4-3 | According to Table 9 of IEC 60601-1 2:2014 | According to Table 9 of IEC 60601-1 2:2014 | Interference may occur in the vicinity of equipment marked with the following symbol:  |

TABLE 4

IEC 60601-1-2:2014 Table 9 – Test specifications for ENCLOSURE PORT IMMUNITY to RF wireless communications equipment

| Test frequency (MHz) | Band ^{a)} (MHz) | Service ^{a)} | Modulation ^{b)} | Maximum power (W) | Distance (m) | IMMUNITY TEST LEVEL (V/m) |
|----------------------|--------------------------|--|---|-------------------|--------------|---------------------------|
| 385 | 380 - 390 | TETRA 400 | Pulse modulation ^{b)} 18 Hz | 1,8 | 0,3 | 27 |
| 450 | 430 - 470 | GMRS 460, FRS 460 | FM ^{c)} 5 kHz deviation 1 kHz sine | 2 | 0,3 | 28 |
| 710 | 704 - 787 | LTE Band 13, 17 | Pulse modulation ^{b)} 217 Hz | 0,2 | 0,3 | 9 |
| 745 | | | | | | |
| 780 | | | | | | |
| 810 | 800 - 960 | GSM 800/900, TETRA 800, iDEN 820, CDMA 850, LTE Band 5 | Pulse modulation ^{b)} 18 Hz | 2 | 0,3 | 28 |
| 870 | | | | | | |
| 930 | | | | | | |
| 1720 | 1 700 - 1 990 | GSM 1800; CDMA 1900; GSM 1900; DECT; LTE Band 1, 3, 4, 25; UMTS | Pulse modulation ^{b)} 217 Hz | 2 | 0,3 | 28 |
| 1 845 | | | | | | |
| 1 970 | | | | | | |
| 2 450 | 2 400 - 2 570 | Bluetooth, WLAN, 802.11 b/g/n, RFID 2450, LTE Band 7 | Pulse modulation ^{b)} 217 Hz | 2 | 0,3 | 28 |
| 5 240 | 5 100 - 5800 | WLAN 802.11 a/n | Pulse modulation ^{b)} 217 Hz | 0,2 | 0,3 | 9 |
| 5 500 | | | | | | |
| 5 785 | | | | | | |

NOTE: If necessary to achieve the IMMUNITY TEST LEVEL, the distance between the transmitting antenna and the ME EQUIPMENT OR ME SYSTEM may be reduced to 1 m. The 1 m test distance is permitted by IEC 61000-4-3.

a) For some services, only the uplink frequencies are included.

b) The carrier shall be modulated using a 50 % duty cycle square wave signal.

c) As an alternative to FM modulation, 50 % pulse modulation at 18 Hz may be used because while it does not represent actual modulation, it would be worst case.

IMPORTANT INFORMATION REGARDING ELECTROMAGNETIC COMPATIBILITY (EMC)

This electrical medical equipment needs special precautions regarding EMC and shall be put into service according to the EMC information provided in this user manual. The equipment conforms to IEC 60601-1-2:2014 for both immunity and emissions. Nevertheless, special precautions need to be observed. This equipment has no ESSENTIAL PERFORMANCE and is intended for Home Healthcare environment. WARNING: Use of this equipment adjacent to or stacked with other equipment should be avoided because it could result in improper operation. If such use is necessary, this equipment should be avoided because it could result in improper operation. If such use is necessary, this equipment and the other equipment should be observed to verify that they are operating normally.

The use of accessories, transducers and cables other than those specified or provided by the manufacturer of this equipment could result in increased electromagnetic emissions or decreased electromagnetic immunity of this equipment and result in improper operation.

WARNING: Portable RF communications equipment (including peripherals such as antenna cables and external antennas) should be used no closer than 30 cm (12 inches) to any part of the Mya Joy PLUS, including cables specified by the manufacturer. Otherwise, degradation of the performance of this equipment could result.

WARNING: If the use location is near (e.g. less than 1.5 km from) AM, FM or TV broadcast antennas, before using this equipment, it should be observed to verify that it is operating normally to assure that the equipment remains safe with regard to electromagnetic disturbances throughout the expected service life. When the AC input voltage is interrupted, the equipment will stop battery charging and if the power supply restored, it could be recovered automatically. This degradation could be accepted because it will not lead to unacceptable risks and it will not result in the loss of basic safety or essential performance.

12.3 Product Disposal

This product contains electrical and electronic equipment.

- 
1. The internal components of this product may contain hazardous materials. Dispose of this product according to local or regional waste administration systems and regulations. Caution: Hazardous materials present in electric and electronic equipment may harm human health and the environment if the equipment is not properly disposed of.
 2. Do not dispose of electric or electronic equipment together with unsorted municipal waste.
 3. For further information regarding the environmental performance of this product please visit our website www.ameda.com. The breast pump and parts are made of plastics which have an impact on the environment when disposed of. Please recycle according to local regulations.

13. OPERATIONAL & STORAGE CONDITIONS



Operational Conditions



Transport/Storage Conditions

14. TRAVEL



WARNING: Use **ONLY** the AC power adapter recommended for the Ameda Mya Joy PLUS Breast Pump.

INFORMATION: This breast pump contains a lithium-ion battery. Carrying such batteries on airplanes may be restricted. Confirm airline policies prior to travel. Please consult with the country you are visiting to find out if there are any restrictions that pertain to traveling with lithium-ion batteries.

15. AMEDA ACCESSORIES AND SPARE PARTS

SOME PUMPS MAY ALSO INCLUDE SOME OF THESE ACCESSORIES:

You may also be able to order these additional accessories or spare parts online, at a local Ameda retailer or Ameda insurance covered provider, visit www.ameda.com for more information.



Dottie Tote



Minnie Tote



AC Power Adapter



Cool'N Carry Milk Storage Tote



Cooling Element



Breast Milk Storage Bottles



Pump'N Protect 6oz Storage Bags



One-Hand Breast Pump



Bottle Holders



21.0 mm Flexishield™ Areola Stimulator



25.0 mm Breast Flange



28.5 mm Breast Flange



28.5 mm Insert/30.5 mm Breast Flange



32.5/36.0 mm Breast Flange



Valve



Diaphragm



Tubing



Tubing Adapter



Adapter Cap



Locking Ring



Locking Disk

16. SYMBOLS REFERENCE

1. ISO 15223-1, Medical devices – Symbols to be used with medical device labels, labelling and information to be supplied, Part 1: General requirements, Clause 5.3.1, Fragile, handle with care / ISO 7000-0621, Graphical symbols for use on equipment, Fragile, handle with care
2. ISO 15223-1, Medical devices – Symbols to be used with medical device labels, labelling and information to be supplied, Part 1: General requirements, Clause 5.3.2 Keep away from sunlight / ISO 7000-0624, Graphical symbols for use on equipment, Keep away from sunlight
3. ISO 15223-1, Medical devices – Symbols to be used with medical device labels, labelling and information to be supplied, Part 1: General requirements, Clause 5.3.4, Keep away from rain / ISO 7000-0626, Graphical symbols for use on equipment, Keep away from rain
4. ISO 15223-1, Medical devices – Symbols to be used with medical device labels, labelling and information to be supplied, Part 1: General requirements, Clause 5.3.7 Temperature Limit / ISO 7000-0632, Graphical symbols for use on equipment, Temperature Limit
5. ISO 15223-1, Medical devices – Symbols to be used with medical device labels, labelling and information to be supplied, Part 1: General requirements, Clause 5.3.8 Humidity Limit / ISO 7000-2620, Graphical symbols for use on equipment, Humidity Limit
6. ISO 15223-1, Medical devices – Symbols to be used with medical device labels, labelling and information to be supplied, Part 1: General requirements, Clause 5.3.8 Humidity Limit / ISO 7000-2620, Graphical symbols for use on equipment, pressure Limit
7. ISO 15223-1, Medical devices – Symbols to be used with medical device labels, labelling and information to be supplied, Part 1: General requirements, Clause 5.1.1 Manufacturer
8. ISO 15223-1, Medical devices – Symbols to be used with medical device labels, labelling and information to be supplied, Part 1: General requirements, Clause 5.1.6 Article number / ISO 7000- 2493, Graphical symbols for use on equipment, batch code
9. ISO 15223-1, Medical devices – Symbols to be used with medical device labels, labelling and information to be supplied, Part 1: General requirements, Clause 5.1.7 Serial number / ISO 7000-2498, Graphical symbols for use on equipment, Serial number
10. ISO 15223-1, Medical devices – Symbols to be used with medical device labels, labelling and information to be supplied, Part 1: General requirements, Clause 5.1.6 Article number / ISO 7000- 2493, Graphical symbols for use on equipment, Catalogue number
11. IEC 60601-1, Medical electrical equipment – Part 1: General Requirements for basic safety and essential performance, Table D.1 Symbol 9 Class II equipment
12. IEC 60601-1, Medical electrical equipment – Part 1: General Requirements for basic safety and essential performance, Table D.1 Symbol 20 Type BF applied parts
13. EN 50419, Marking of Electrical and Electronic Equipment in accordance with Article 11(2) of Directive 2002/96/EC (WEEE)
14. IEC 60601-1, Medical electrical equipment – Part 1: General Requirements for basic safety and essential performance, Table D.1 Symbol 4 Alternating current
15. IEC 60601-1, Medical electrical equipment – Part 1: General Requirements for basic safety and essential performance, Table D.1 Symbol 1 Direct current
16. IEC 60601-1, Medical electrical equipment – Part 1: General Requirements for basic safety and essential performance, Table D.1 Symbol 29 Stand-by
17. IEC 60417-5957, Graphical symbols for use on equipment
18. IEC TR 60878:2015 – Graphical symbols for electrical equipment in medical practice



To register your pump:

Please visit [ameda.com/register-your-pump](https://www.ameda.com/register-your-pump) and input the serial number (SN) from the bottom of your pump.

Distributed in USA by:

Ameda, Inc.
485 Half Day Road
Buffalo Grove, IL 60089
1.866.992.6332
www.ameda.com

Distributed in Canada by:

Mothers Choice Products Ltd.
2133-11871 Horseshoe Way
Richmond, BC V7A5H5
1-800-604-6225
www.motherschoiceproducts.com



Ameda Inc.
485 Half Day Road
Suite 320
Buffalo Grove, IL 60089